

IRLML0060TRPbF

HEXFET® Power MOSFET

| | | |
|---|-------------|-----------|
| V_{DS} | 60 | V |
| $V_{GS\ Max}$ | ± 16 | V |
| $R_{DS(on)\ max}$ (@ $V_{GS} = 10V$) | 92 | mΩ |
| $R_{DS(on)\ max}$ (@ $V_{GS} = 4.5V$) | 116 | mΩ |

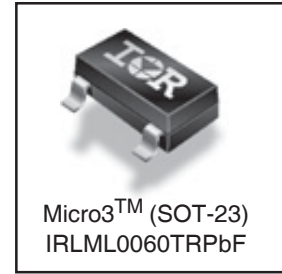
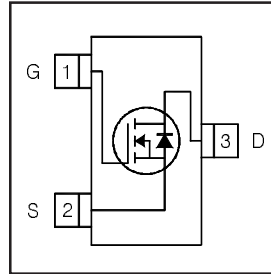

Application(s)

- Load/ System Switch

Features and Benefits

Features

| |
|--|
| Industry-standard pinout |
| Compatible with existing Surface Mount Techniques |
| RoHS compliant containing no lead, no bromide and no halogen |
| MSL1, Industrial qualification |

results in

⇒

Benefits

| |
|----------------------------|
| Multi-vendor compatibility |
| Easier manufacturing |
| Environmentally friendly |
| Increased reliability |

Absolute Maximum Ratings

| Symbol | Parameter | Max. | Units |
|--------------------------|--|--------------|-------|
| V_{DS} | Drain-Source Voltage | 60 | V |
| $I_D @ T_A = 25^\circ C$ | Continuous Drain Current, $V_{GS} @ 10V$ | 2.7 | A |
| $I_D @ T_A = 70^\circ C$ | Continuous Drain Current, $V_{GS} @ 10V$ | 2.1 | |
| I_{DM} | Pulsed Drain Current | 11 | W |
| $P_D @ T_A = 25^\circ C$ | Maximum Power Dissipation | 1.25 | |
| $P_D @ T_A = 70^\circ C$ | Maximum Power Dissipation | 0.80 | |
| | Linear Derating Factor | 0.01 | |
| V_{GS} | Gate-to-Source Voltage | ± 16 | V |
| T_J, T_{STG} | Junction and Storage Temperature Range | -55 to + 150 | °C |

Thermal Resistance

| Symbol | Parameter | Typ. | Max. | Units |
|-----------------|-------------------------------------|------|------|-------|
| $R_{\theta JA}$ | Junction-to-Ambient ③ | — | 100 | °C/W |
| $R_{\theta JA}$ | Junction-to-Ambient ($t < 10s$) ④ | — | 99 | |

ORDERING INFORMATION:

See detailed ordering and shipping information on the last page of this data sheet.

Notes ① through ④ are on page 10

www.irf.com

Electric Characteristics @ $T_J = 25^\circ\text{C}$ (unless otherwise specified)

| Symbol | Parameter | Min. | Typ. | Max. | Units | Conditions |
|---------------------------------|--------------------------------------|------|------|------|---------------------|--|
| $V_{(BR)DSS}$ | Drain-to-Source Breakdown Voltage | 60 | — | — | V | $V_{GS} = 0V, I_D = 250\mu A$ |
| $\Delta V_{(BR)DSS}/\Delta T_J$ | Breakdown Voltage Temp. Coefficient | — | 0.06 | — | V/ $^\circ\text{C}$ | Reference to $25^\circ\text{C}, I_D = 1\text{mA}$ |
| $R_{DS(on)}$ | Static Drain-to-Source On-Resistance | — | 98 | 116 | $m\Omega$ | $V_{GS} = 4.5V, I_D = 2.2A$ ② |
| | | — | 78 | 92 | | $V_{GS} = 10V, I_D = 2.7A$ ② |
| $V_{GS(th)}$ | Gate Threshold Voltage | 1.0 | — | 2.5 | V | $V_{DS} = V_{GS}, I_D = 25\mu A$ |
| I_{DSS} | Drain-to-Source Leakage Current | — | — | 20 | μA | $V_{DS} = 60V, V_{GS} = 0V$ |
| | | — | — | 250 | | $V_{DS} = 60V, V_{GS} = 0V, T_J = 125^\circ\text{C}$ |
| I_{GSS} | Gate-to-Source Forward Leakage | — | — | 100 | nA | $V_{GS} = 20V$ |
| | Gate-to-Source Reverse Leakage | — | — | -100 | | $V_{GS} = -20V$ |
| R_G | Internal Gate Resistance | — | 1.6 | — | Ω | |
| g_{fs} | Forward Transconductance | 7.6 | — | — | S | $V_{DS} = 25V, I_D = 2.7A$ |
| Q_g | Total Gate Charge | — | 2.5 | — | nC | $I_D = 2.7A$ |
| Q_{gs} | Gate-to-Source Charge | — | 0.7 | — | | $V_{DS} = 30V$ |
| Q_{gd} | Gate-to-Drain ("Miller") Charge | — | 1.3 | — | | $V_{GS} = 4.5V$ ② |
| $t_{d(on)}$ | Turn-On Delay Time | — | 5.4 | — | ns | $V_{DD} = 30V$ ② |
| t_r | Rise Time | — | 6.3 | — | | $I_D = 1.0A$ |
| $t_{d(off)}$ | Turn-Off Delay Time | — | 6.8 | — | | $R_G = 6.8\Omega$ |
| t_f | Fall Time | — | 4.2 | — | | $V_{GS} = 4.5V$ |
| C_{iss} | Input Capacitance | — | 290 | — | pF | $V_{GS} = 0V$ |
| C_{oss} | Output Capacitance | — | 37 | — | | $V_{DS} = 25V$ |
| C_{rss} | Reverse Transfer Capacitance | — | 21 | — | | $f = 1.0\text{MHz}$ |

Source - Drain Ratings and Characteristics

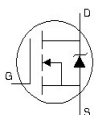
| Symbol | Parameter | Min. | Typ. | Max. | Units | Conditions |
|----------|---|------|------|------|-------|--|
| I_S | Continuous Source Current (Body Diode) | — | — | 1.6 | A | MOSFET symbol showing the integral reverse p-n junction diode.  |
| I_{SM} | Pulsed Source Current (Body Diode) ① | — | — | 11 | | |
| V_{SD} | Diode Forward Voltage | — | — | 1.3 | V | $T_J = 25^\circ\text{C}, I_S = 2.7A, V_{GS} = 0V$ ② |
| t_{rr} | Reverse Recovery Time | — | 14 | 21 | ns | $T_J = 25^\circ\text{C}, V_R = 30V, I_F = 1.6A$ |
| Q_{rr} | Reverse Recovery Charge | — | 13 | 20 | nC | $di/dt = 100A/\mu s$ ② |

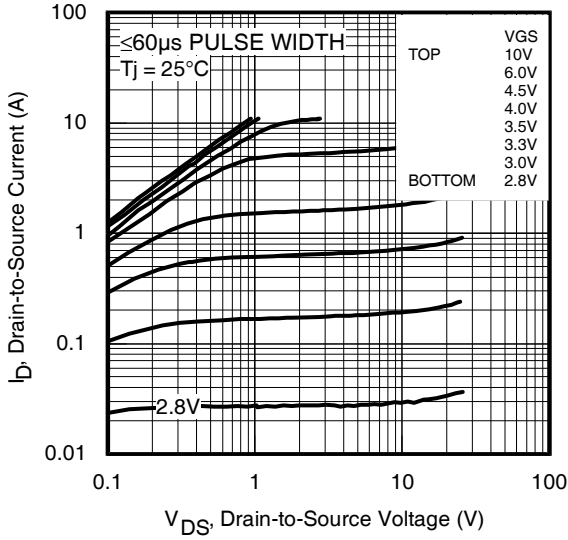

Fig 1. Typical Output Characteristics

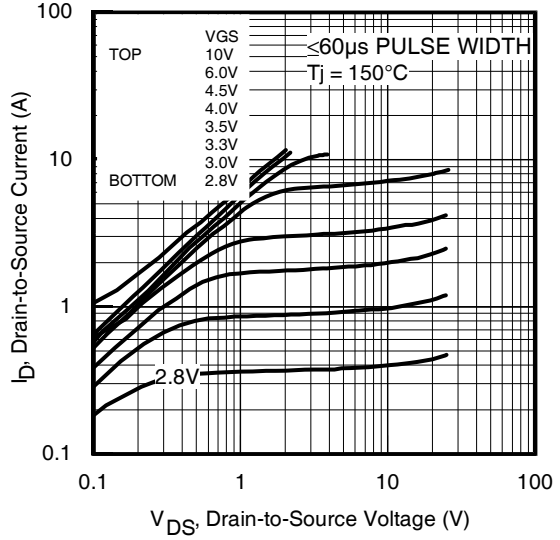

Fig 2. Typical Output Characteristics

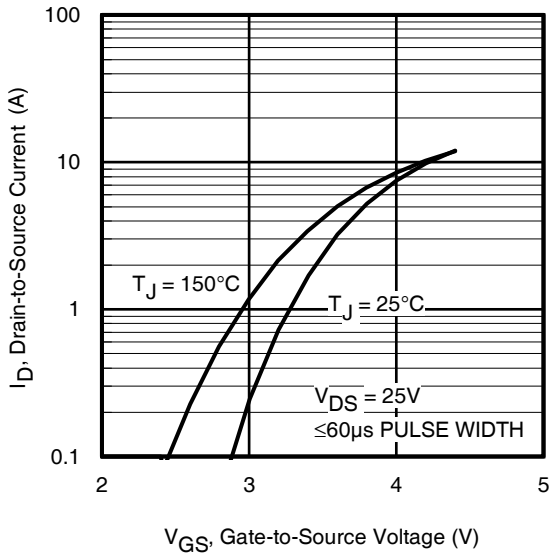

Fig 3. Typical Transfer Characteristics

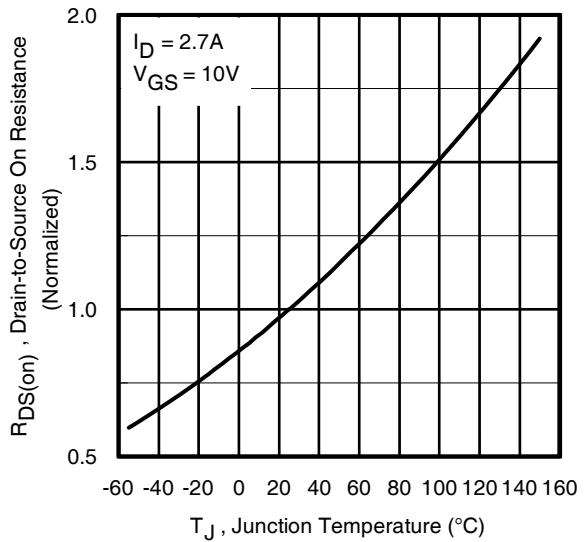

Fig 4. Normalized On-Resistance vs. Temperature

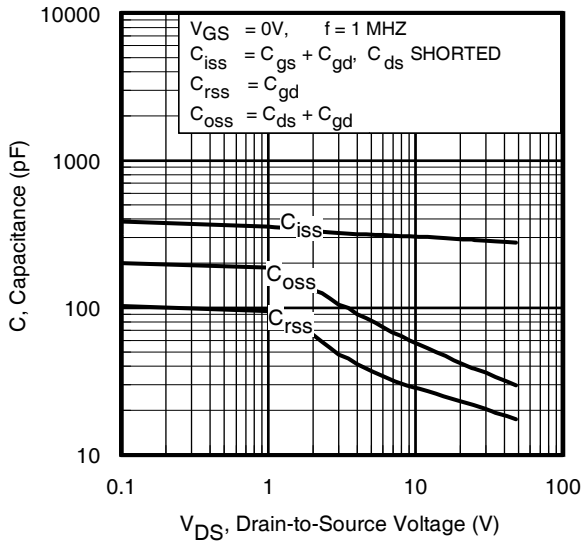

Fig 5. Typical Capacitance vs. Drain-to-Source Voltage

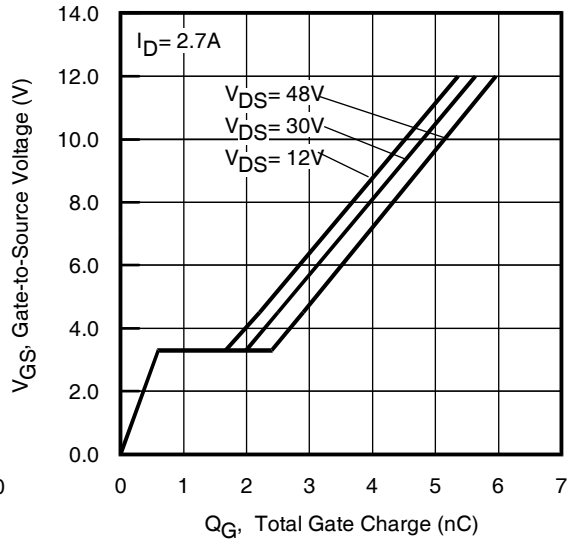

Fig 6. Typical Gate Charge vs. Gate-to-Source Voltage

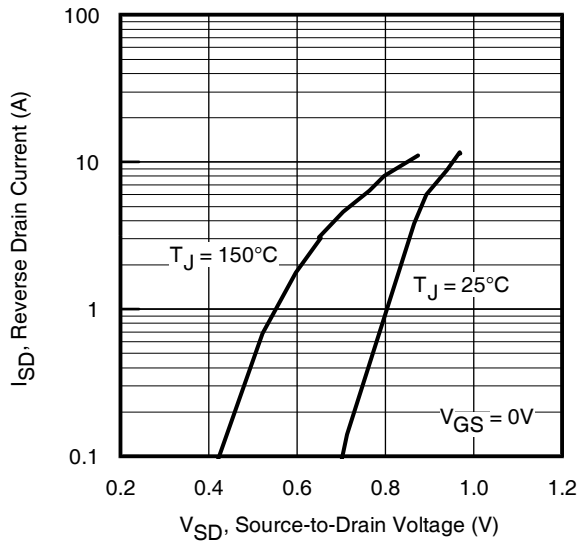

Fig 7. Typical Source-Drain Diode Forward Voltage

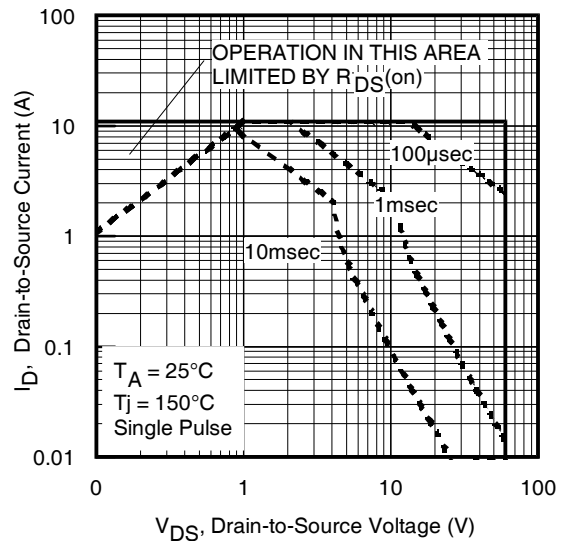

Fig 8. Maximum Safe Operating Area

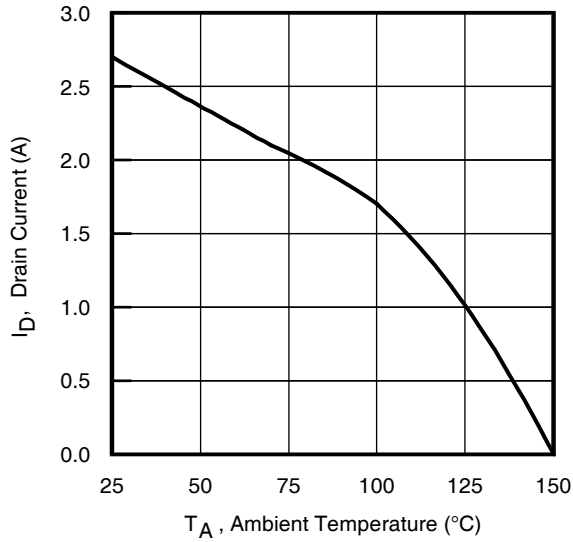

Fig 9. Maximum Drain Current vs. Ambient Temperature

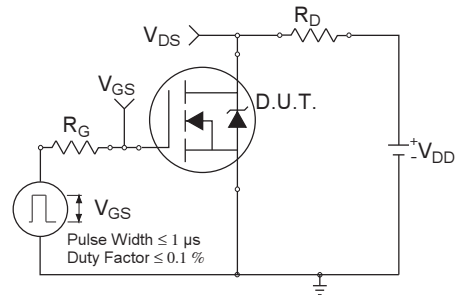

Fig 10a. Switching Time Test Circuit



Fig 10b. Switching Time Waveforms

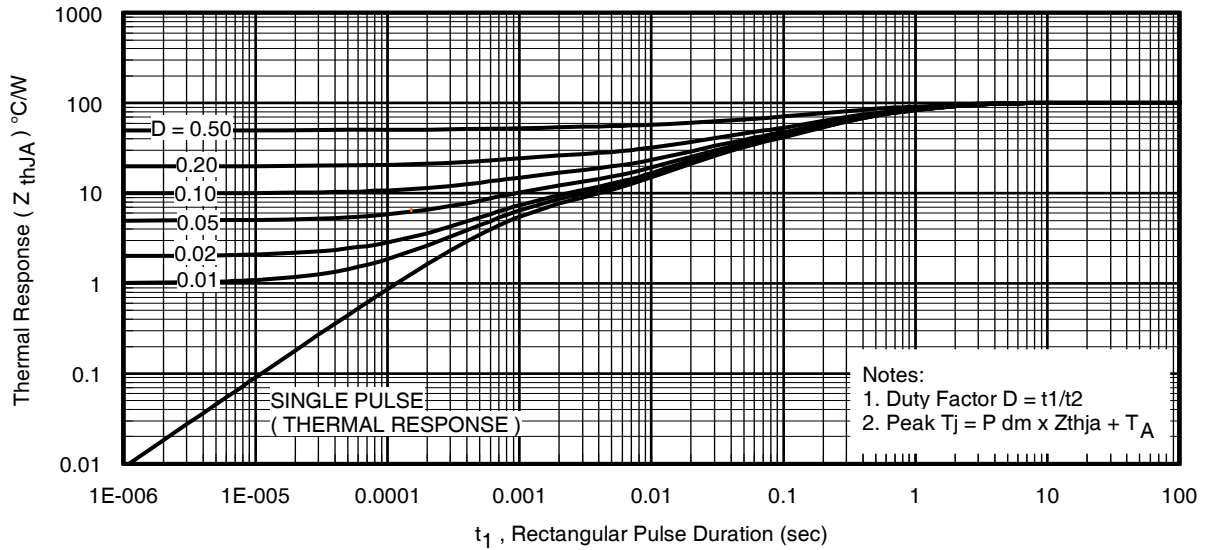

Fig 11. Typical Effective Transient Thermal Impedance, Junction-to-Ambient

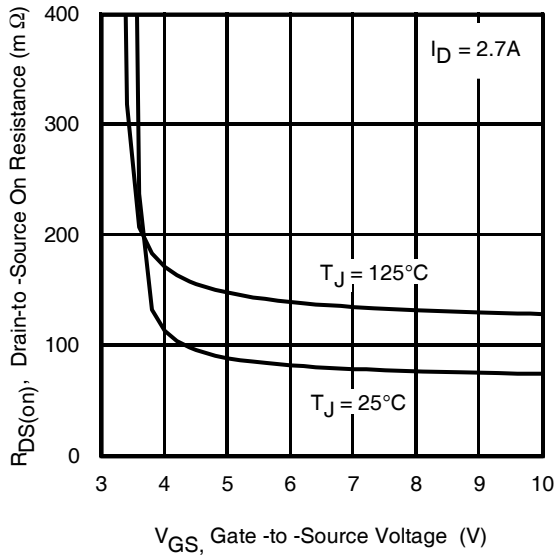

Fig 12. Typical On-Resistance vs. Gate Voltage

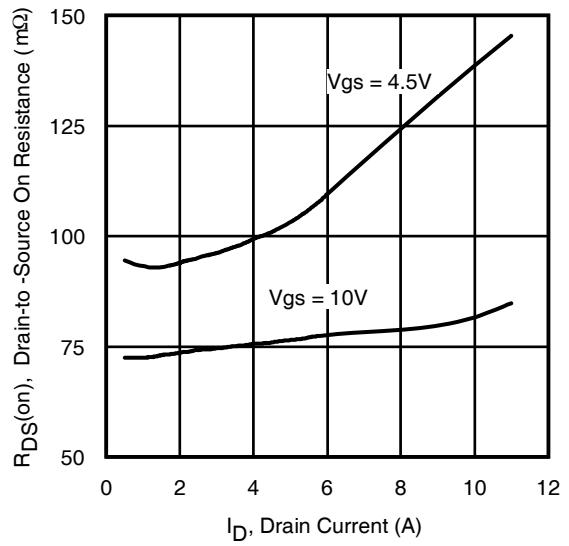

Fig 13. Typical On-Resistance vs. Drain Current

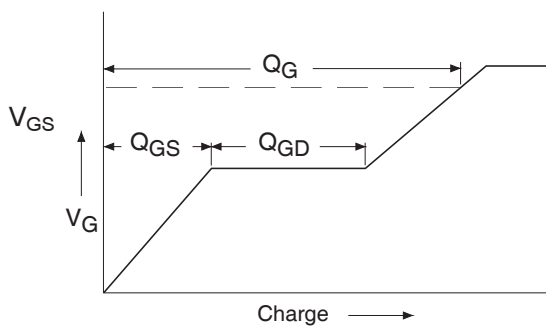

Fig 14a. Basic Gate Charge Waveform

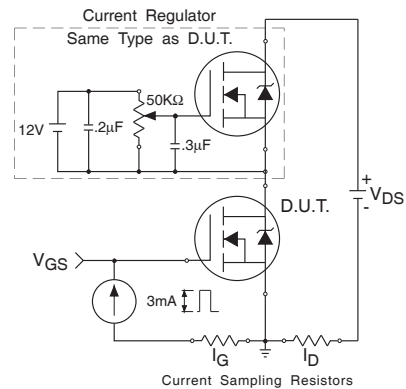

Fig 14b. Gate Charge Test Circuit

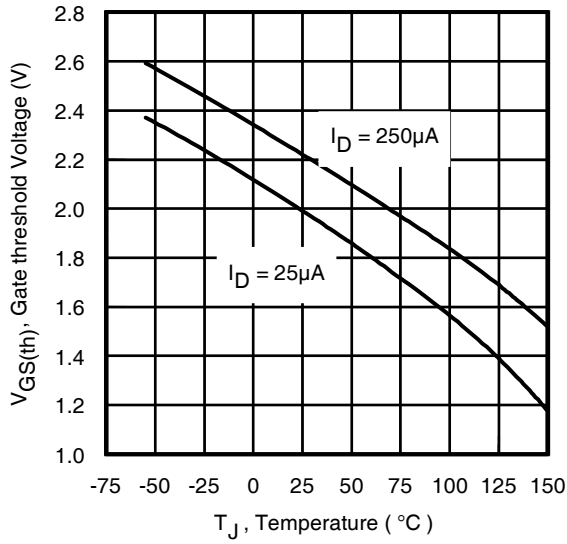

Fig 15. Typical Threshold Voltage vs. Junction Temperature

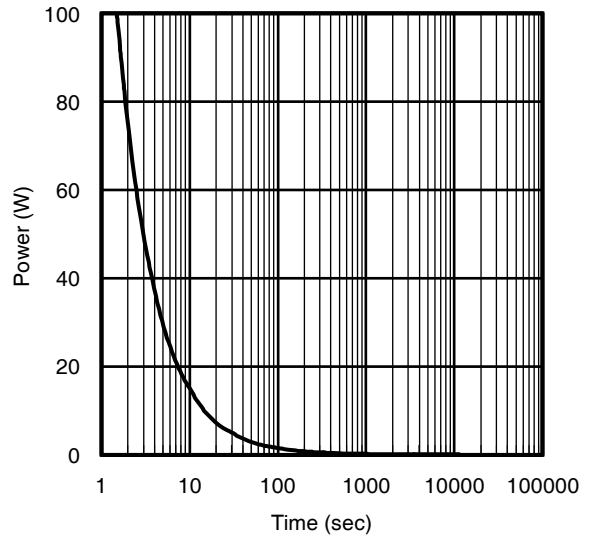

Fig 16. Typical Power vs. Time

IRLML0060TRPbF

International
IR Rectifier

Micro3 (SOT-23) Package Outline

Dimensions are shown in millimeters (inches)

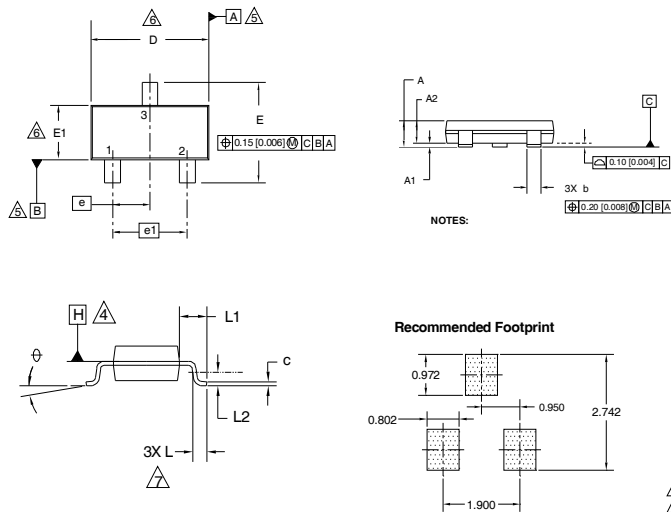

| DIMENSIONS | | | | |
|---------------|-------------|------|--------|-------|
| SYMBOL | MILLIMETERS | | INCHES | |
| | MIN | MAX | MIN | MAX |
| A | 0.89 | 1.12 | 0.035 | 0.044 |
| A1 | 0.01 | 0.10 | 0.0004 | 0.004 |
| A2 | 0.88 | 1.02 | 0.035 | 0.040 |
| b | 0.30 | 0.50 | 0.012 | 0.020 |
| c | 0.08 | 0.20 | 0.003 | 0.008 |
| D | 2.80 | 3.04 | 0.110 | 0.120 |
| E | 2.10 | 2.64 | 0.083 | 0.104 |
| E1 | 1.20 | 1.40 | 0.047 | 0.055 |
| e | 0.95 | BSC | 0.037 | BSC |
| e1 | 1.90 | BSC | 0.075 | BSC |
| L | 0.40 | 0.60 | 0.016 | 0.024 |
| L1 | 0.54 | REF | 0.021 | REF |
| L2 | 0.25 | BSC | 0.010 | BSC |
| \varnothing | 0 | 8 | 0 | 8 |

1. DIMENSIONING & TOLERANCING PER ANSI Y14.5M-1994
2. DIMENSIONS ARE SHOWN IN MILLIMETERS (INCHES).
3. CONTROLLING DIMENSION: MILLIMETER
4. DATUM PLANE H IS LOCATED AT THE MOLD PARTING LINE.
5. DATUM A AND B TO BE DETERMINED AT DATUM PLANE H.
6. DIMENSIONS D AND E1 ARE MEASURED AT DATUM PLANE H. DIMENSIONS DOES NOT INCLUDE MOLD PROTRUSIONS OR INTERLEAD FLASH. MOLD PROTRUSIONS OR INTERLEAD FLASH SHALL NOT EXCEED 0.25 MM (0.010 INCH) PER SIDE.
7. DIMENSION L IS THE LEAD LENGTH FOR SOLDERING TO A SUBSTRATE.
8. OUTLINE CONFORMS TO JEDEC OUTLINE TO-236 AB.

Micro3 (SOT-23/TO-236AB) Part Marking Information

Notes: This part marking information applies to devices produced after 02/26/2001

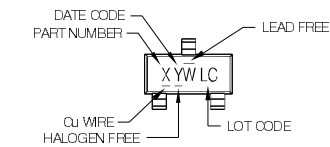

X = PART NUMBER CODE REFERENCE:

| | |
|---------------|---------------|
| A = IRLML2402 | S = IRLML6244 |
| B = IRLML2803 | T = IRLML6246 |
| C = IRLML6302 | U = IRLML6344 |
| D = IRLML5103 | V = IRLML6346 |
| E = IRLML6402 | W = IFFML8244 |
| F = IRLML6401 | X = IRLML2244 |
| G = IRLML2502 | Y = IRLML2246 |
| H = IRLML6203 | Z = IFFML8244 |
| I = IRLML0030 | |
| J = IRLML2030 | |
| K = IRLML0100 | |
| L = IRLML0060 | |
| M = IRLML0040 | |
| N = IRLML2060 | |
| P = IRLML9301 | |
| R = IRLML9303 | |

Note: A line above the work week (as shown here) indicates Lead-Free.

DATE CODE MARKING INSTRUCTIONS

WW = (1-26) IF PRECEDED BY LAST DIGIT OF CALENDAR YEAR

| YEAR | Y | WORK WEEK | W |
|------|------|-----------|----|
| 2011 | 2001 | 1 | 01 |
| 2012 | 2002 | 2 | 02 |
| 2013 | 2003 | 3 | 03 |
| 2014 | 2004 | 4 | 04 |
| 2015 | 2005 | 5 | |
| 2016 | 2006 | 6 | |
| 2017 | 2007 | 7 | |
| 2018 | 2008 | 8 | |
| 2019 | 2009 | 9 | |
| 2020 | 2010 | 0 | 24 |
| | | | 25 |
| | | | 26 |
| | | | X |
| | | | Y |
| | | | Z |

WW = (27-52) IF PRECEDED BY A LETTER

| YEAR | Y | WORK WEEK | W |
|------|------|-----------|----|
| 2011 | 2001 | A | 27 |
| 2012 | 2002 | B | 28 |
| 2013 | 2003 | C | 29 |
| 2014 | 2004 | D | 30 |
| 2015 | 2005 | E | |
| 2016 | 2006 | F | |
| 2017 | 2007 | G | |
| 2018 | 2008 | H | |
| 2019 | 2009 | J | |
| 2020 | 2010 | K | 50 |
| | | | 51 |
| | | | 52 |
| | | | X |
| | | | Y |
| | | | Z |

Note: For the most current drawing please refer to IR website at: <http://www.irf.com/package/>

Micro3™ Tape & Reel Information

Dimensions are shown in millimeters (inches)

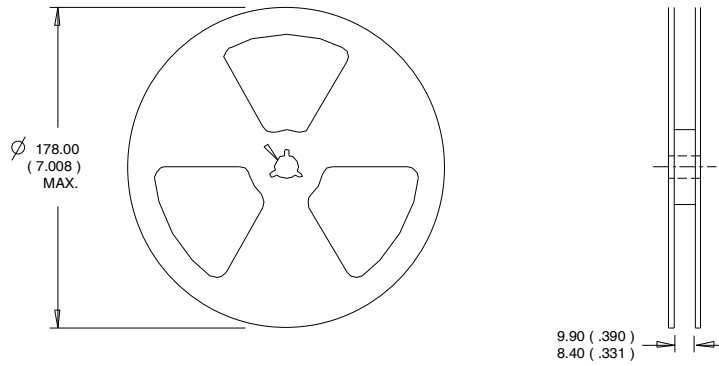
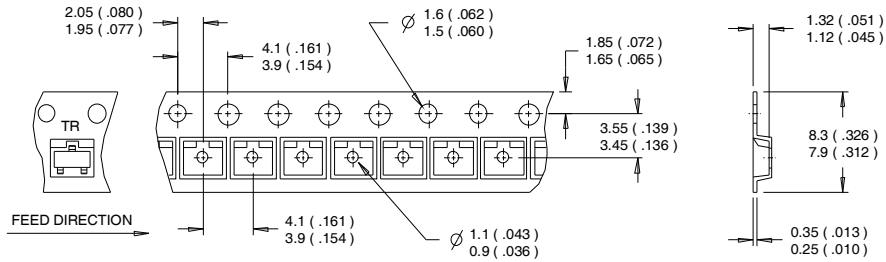

- NOTES:
 1. CONTROLLING DIMENSION : MILLIMETER.
 2. OUTLINE CONFORMS TO EIA-481 & EIA-541.

Note: For the most current drawing please refer to IR website at: <http://www.irf.com/package/>

IRLML0060TRPbF

International
IR Rectifier

| Orderable part number | Package Type | Standard Pack | | Note |
|-----------------------|-----------------|---------------|----------|------|
| | | Form | Quantity | |
| IRLML0060TRPbF | Micro3 (SOT-23) | Tape and Reel | 3000 | |

Qualification information[†]

| | | |
|----------------------------|--|--|
| Qualification level | Consumer ^{††} (per JEDEC JES D47F ^{†††} guidelines) | |
| Moisture Sensitivity Level | Micro3 (SOT-23) | MSL1 (per IPC/JEDEC J-STD-020D ^{†††}) |
| RoHS compliant | Yes | |

- † Qualification standards can be found at International Rectifier's web site
<http://www.irf.com/product-info/reliability>
- †† Higher qualification ratings may be available should the user have such requirements.
Please contact your International Rectifier sales representative for further information:
<http://www.irf.com/whoto-call/salesrep/>
- ††† Applicable version of JEDEC standard at the time of product release.

Notes:

- ① Repetitive rating; pulse width limited by max. junction temperature.
- ② Pulse width $\leq 400\mu\text{s}$; duty cycle $\leq 2\%$.
- ③ Surface mounted on 1 in square Cu board.
- ④ Refer to [application note #AN-994](#).

Data and specifications subject to change without notice.

International
IR Rectifier

IR WORLD HEADQUARTERS: 101 N. Sepulveda Blvd., El Segundo, California 90245, USA Tel: (310) 252-7105
TAC Fax: (310) 252-7903

Visit us at www.irf.com for sales contact information. 03/12